

YAMAHA R-700

Natural Sound Stereo Receiver

Unique Yamaha Station Locked Synthesizer Tuning System

Remarkable Spatial Expander Control

5 FM/5 AM Station Preset Tuning

Precise Digital Frequency Readout, Auto DX, FM Muting

Continuously Variable Loudness Control, Signal Quality Indicator



OWNER'S MANUAL



Thank you for purchasing the YAMAHA R-700 AM/FM stereo receiver.
This receiver comes with a full range of features for the ultimate in audio performance. It provides exceptionally accurate music reproduction under even the most demanding reception conditions.
Please read these instructions through before operating your R-700 and retain this booklet for reference to ensure that you will gain the maximum from your R-700 through many years of use.

CONTENTS

CAUTION: READ THIS BEFORE OPERATING YOUR R-700	2
CONNECTION DIAGRAM/REAR PANELS	3/4
CONNECTIONS	5/6
FRONT PANEL PARTS AND FUNCTIONS	7/8/9
LISTENING TO A PROGRAM SOURCE	10
PRESET TUNING/MEMORY BACK-UP POWER SUPPLY	11
SPECIFICATIONS	12
TROUBLESHOOTING	13
BLOCK DIAGRAM	14

IMPORTANT

Please record the serial number of your unit in the space below.

Model: R-700
Serial No.:

The serial number is located on the rear of the cabinet. Retain this Owner's Manual in a safe place for future reference.

Special Instructions for British Model

THE WIRES IN THE MAINS LEAD ARE COLOURED IN ACCORDANCE WITH THE FOLLOWING CODE:

Blue: NEUTRAL
Brown: LIVE

As the colours of the wires in the mains lead of this apparatus may not correspond with the coloured markings identifying the terminals in your plug, proceed as follows. The wire which is coloured BLUE must be connected to the terminal which is marked with the letter N or coloured BLACK. The wire which is coloured BROWN must be connected to the terminal which is marked with the letter L or coloured RED.

WARNING

To prevent fire or shock hazard, do not expose this appliance to rain or moisture.

R-700

**CAUTION:
READ THIS BEFORE OPERATING
YOUR R-700**

1 The R-700 is a sophisticated stereo receiver. To ensure proper operation for the best possible performance, please read this manual carefully.

2 Choose the installation location of your R-700 carefully. Avoid placing it in direct sunlight or close to a source of heat. Also avoid locations subject to vibration and excessive dust, heat, cold or moisture. Keep it away from such sources of hum as transformers or motors.

3 Do not open the cabinet as this might result in damage to the set or electrical shock. If a foreign object should get into the set, contact your dealer.

4 Do not place records or other objects on top of the receiver so that the ventilation holes are blocked. This will cause the internal temperature to rise and may result in a failure.

5 When removing the power plug from the wall outlet, always pull directly on the plug; never yank the cord.

6 To prevent lightning damage, pull out the power cord and remove the antenna cable in case of an electrical storm.

7 Do not use force when using the switches and knobs.

8 When moving the set be sure to first pull out the power plug and remove cords connecting to other equipment.

9 Always set the volume control to "0" while lowering the tonearm to play a record, then turn the volume up after the stylus is seated in the record groove.

10 Do not attempt to clean the R-700 with chemical solvents as this might damage the finish. Use a clean, dry cloth.

11 Be sure to read the "troubleshooting" section for advice on common operating errors before concluding that your R-700 is faulty.

12 Keep this manual in a safe place for future reference.

13 (U.S., Canada & General models only)
Do not connect audio equipment to the AC outlets on the rear panel if that equipment requires more power than the outlets are rated to provide.

14 Voltage Selector (General model only)
The voltage selector switch on the rear panel of the R-700 must be set for your local mains voltage BEFORE plugging it into the AC main supply. Voltages are 110/120/220/240 V AC, 50/60 Hz. (Refer to page 3)

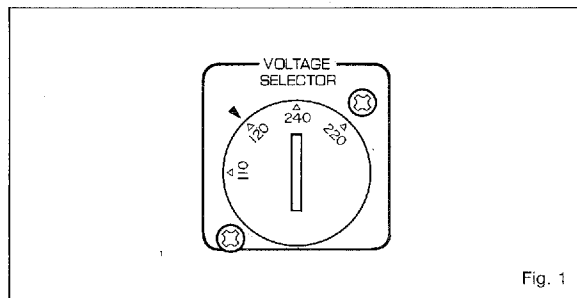

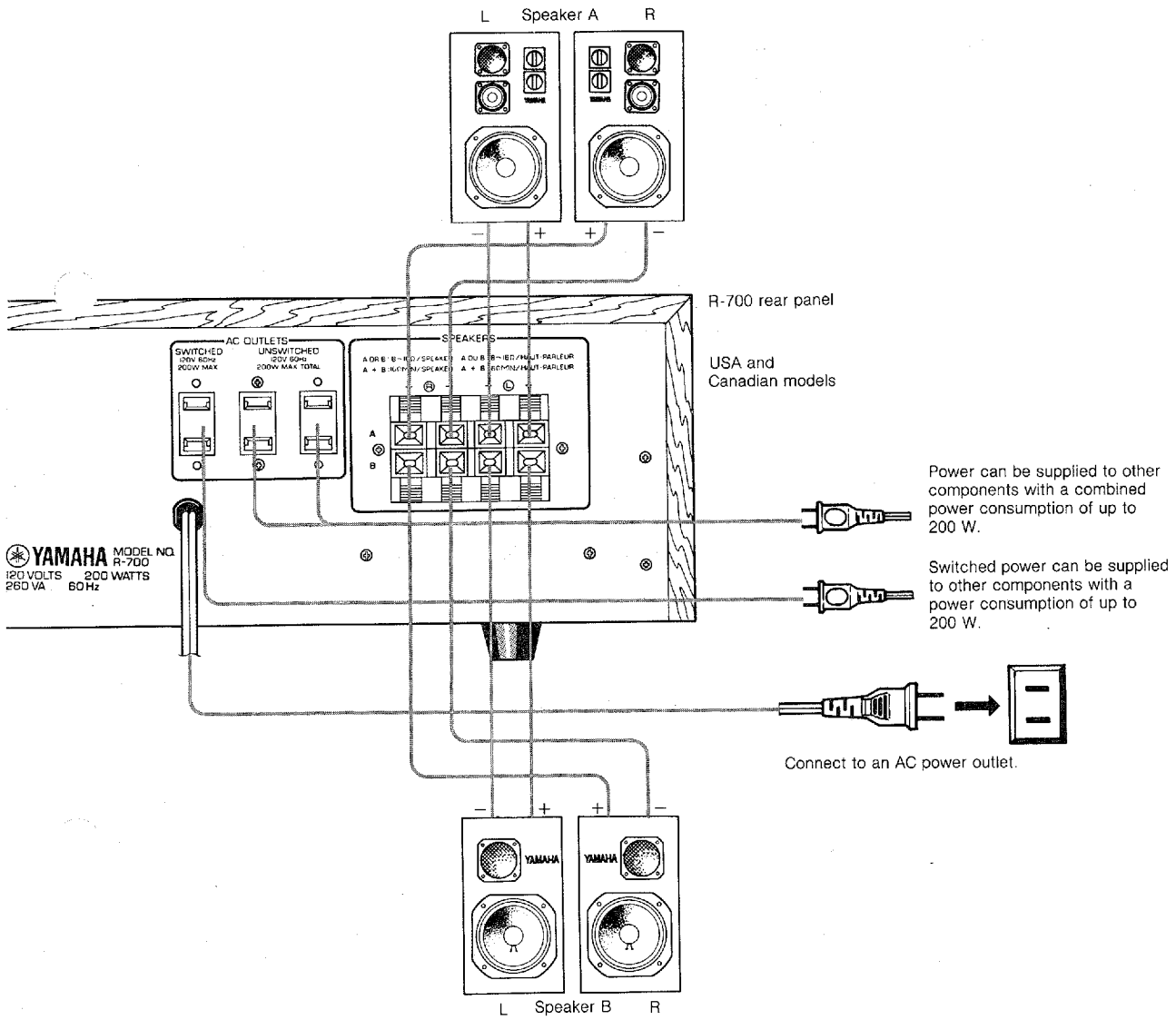

• North European model

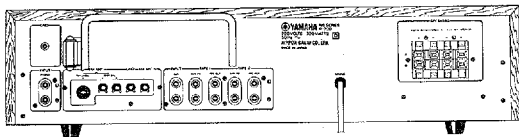

• British and Australian models

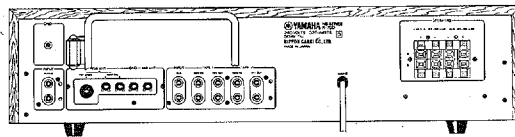

R-700 CONNECTIONS

CONNECTING THE SPEAKERS

The matching impedance of this amplifier is 8 ohms. Either one or two pairs of speakers may be connected. If only one pair is connected the recommended speaker impedance may be anywhere between 4 and 16 ohms. If two pairs are connected, however, it is advisable to use speakers with at least an 8 ohm impedance for optimum performance. Connecting two pair of 4 ohms speakers is not recommended.

Connect the cords going to the left speakers to the L terminals and the right speaker cords to the R terminals, making sure that the "+" and "-" markings are observed. If the "+" and "-" wires are reversed at either speaker, the sound will be unnatural and will lack bass. Speaker cords should be cut as short as possible; do not coil up excess wire on the floor. Also, do not bundle with cords from other system components.

Push in on the lever at the terminal, insert the exposed wire of the speaker cord into the hole and then release the lever. The cord will be locked into position. If these connections are faulty, no sound will be heard from the speakers.

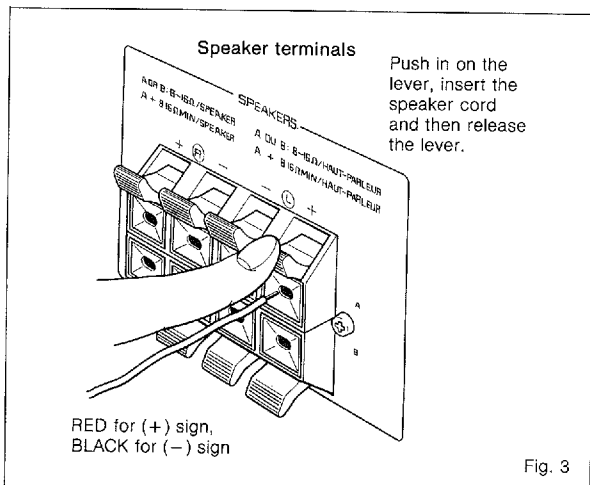

CONNECTING A TURNTABLE

Connect the output cords of the turntable to the receiver's Phono Jacks, and connect the ground wire to the Gnd terminal. Normally, connecting the ground wire produces minimum hum, but in some cases better results are obtained with the ground wire disconnected. The cartridge and the turntable's output cords should be positioned well away from such sources of hum as power cords or power transformers of other system components.

CONNECTING A TAPE DECK

Two tape decks can be connected to this receiver as it has two sets of jacks (Tape 1 and Tape 2). Connect the Tape PB jacks to the tape deck's Line Out jacks, and the Rec Out jacks to the tape deck's Line In jacks.

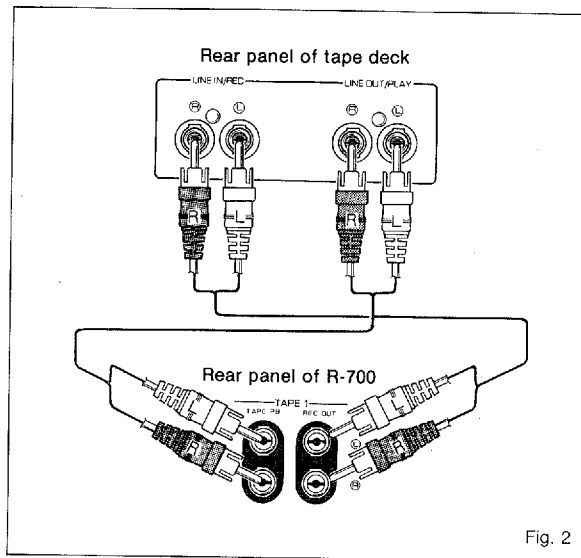

CONNECTING THE AM ANTENNA

In many cases it will be possible to get excellent AM reception with the provided AM loop antenna. Attach the

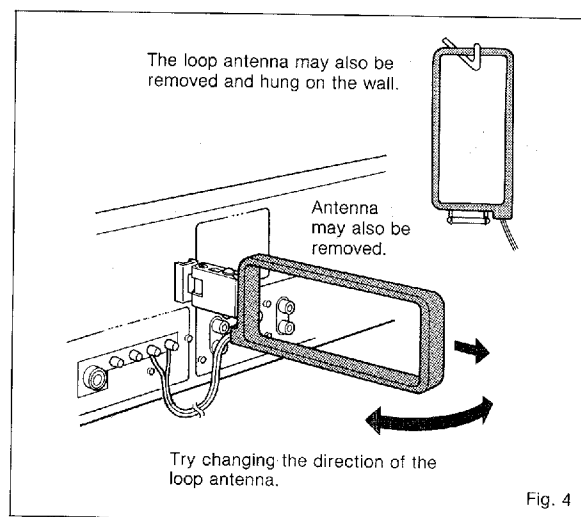

antenna leads to the Gnd and AM Ant terminals and rotate the antenna in its bracket for best reception. The loop antenna may also be removed and hung on the wall. If necessary, an outdoor antenna may be used for improved AM reception. Connect a 5—10 meter length of insulated wire to the AM Ant terminal and run it outdoors.

CONNECTING THE FM ANTENNA

Choose an FM antenna that is appropriate to the local reception conditions. Consider the distance from the broadcast station and possible interfering objects such as surrounding tall buildings. In cases where there is a strong signal from a local station, a portable T-type antenna is usually adequate. Connect the feeder wire to the 300 ohm terminal, stretch the wire out tight, and turn to obtain optimum reception. Attach to a suitable support such as a wall.

In all but the best reception conditions, an outdoor FM antenna is necessary for best results. Either 300 ohm flat twin-lead wire or 75 ohm coaxial cable may be used. In locations where electrical interference is a problem, coaxial cable is preferable. Refer to fig. 5 for instructions on installing the coaxial plug.

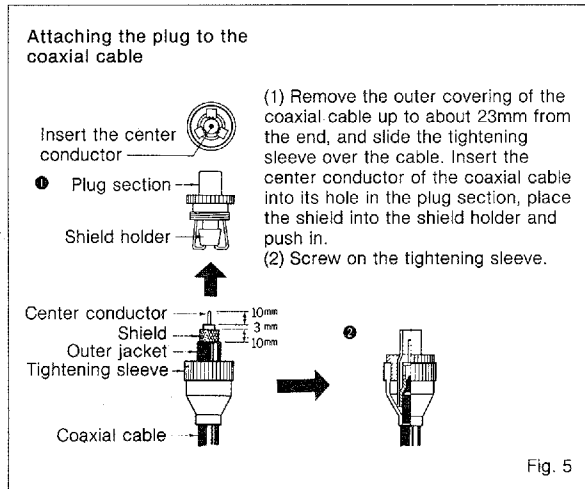

AC OUTLETS (U.S.A., Canadian and General models)

Provided for connecting other audio equipment. The left outlet, with a maximum power capacity of 200 W, is switched on and off by the receiver's power switch; the center and right outlets supply continuous unswitched power up to a combined maximum of 200 W.

VOLTAGE SELECTOR (General model)

Set this to your local AC mains voltage. Failure to do so will result in seriously impaired performance or even severe damage.

■ ALLEN WRENCH

An allen wrench is provided for use in removing or replacing the Input Selector knob.

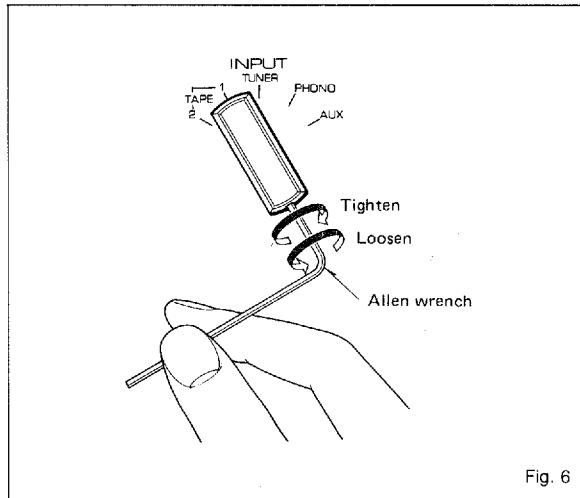

R-700 FRONT PANEL PARTS AND FUNCTION

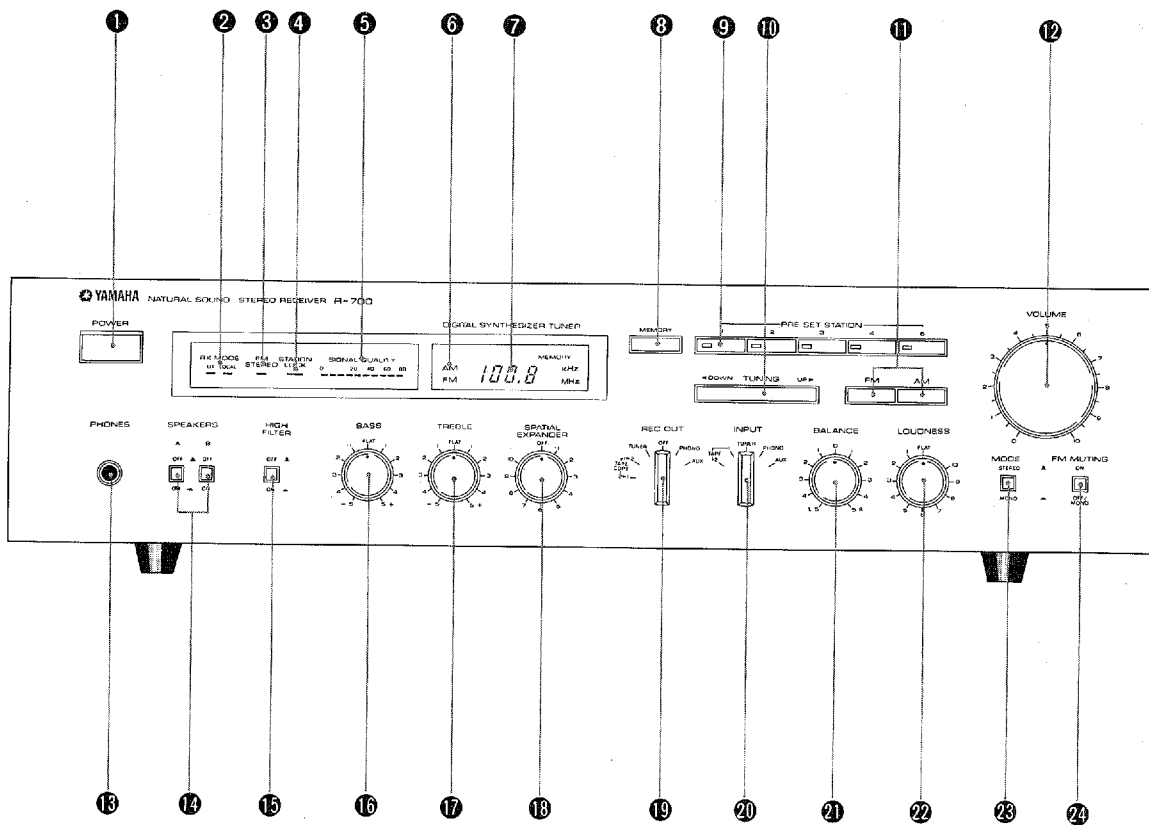

1 POWER SWITCH

This is a "push-on, push-off" type power switch. When power is turned on the red bar above the switch and the digital frequency display will light.
On British, North European and Australian models, the switch is labeled "STANDBY".

2 RX MODE DX

When the received FM station is weak or being interfered with, this indicator lights to show that the R-700 is in DX mode.

LOCAL

When the received FM station is sufficiently strong, this indicator lights to denote local mode. Neither of these indicators function when AM is being received.

3 FM STEREO

When an FM stereo broadcast is being received this indicator automatically lights.

4 STATION LOCK

This indicator lights to show that the SLL synthesizer circuit has locked accurately onto your station for perfect reception. Audio output is automatically blocked on FM until this indicator comes on.

5 SIGNAL QUALITY INDICATOR

This indicator shows the strength of the received station.
*In the case of FM reception, a slight flickering indicates the presence of multipath interference. This can be eliminated by using a directional FM antenna and adjusting its height and direction until the display is stable.

6 AM/FM INDICATOR

Lights to show AM or FM.

7 DIGITAL FREQUENCY READOUT

This displays the frequency of the received station.

8 MEMORY

This button is used to preset station frequencies into the programmable memory. Please refer to page 11.

9 PRESET STATION BUTTONS

5 FM and 5 AM stations can be memorized. When a preset tuning button is pushed, the corresponding station will be immediately tuned in.

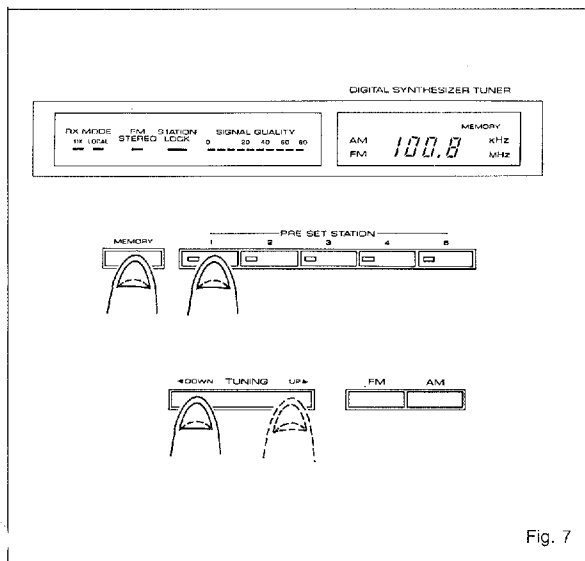

Fig. 7

10 TUNING

This button is used to automatically scan the FM and AM band for stations. Pushing the Up side of the button causes the R-700 to scan to progressively higher frequencies until a station is found and then to lock the station in. Pushing the Down side of the button causes it to scan in the other direction. If the end of the band is reached without finding a station, the auto-search circuit instantly shifts to the opposite end of the band and the search continues in the same direction.

11 BAND SELECT BUTTONS

These switches select either FM or AM broadcasts. The AM/FM Indicator (6) next to the digital display shows the selected band.

12 VOLUME CONTROL

Used to adjust overall sound volume.

13 PHONES JACK

Used for plugging in headphones. When you want to listen to headphones only, Speaker switches A and B should both be set to the Off (I) position.

14 SPEAKER SWITCHES

With these switches, you can select either or both of two sets of speakers.

15 HIGH FILTER SWITCH

This switch is used to remove high-frequency tape hiss or record surface noise, etc.

16 BASS CONTROL

11-position detent control lets you adjust bass response. Set to the center Flat position for normal response.

17 TREBLE CONTROL

11-position detent control lets you adjust treble response. Set to the center Flat position for normal response.

18 SPATIAL EXPANDER CONTROL

Crossfeeds signals from the left and right channels to produce an expanded "wide stereo" effect. Continuously variable from 1 (minimum) to 10 (maximum). The control is defeated in the Off position. There is almost no effect when headphones are used.

19 REC OUT SELECTOR

Used for recording, this switch sends the signal from the selected source to the Rec Out jacks (regardless of the position of the Input Selector switch. See Fig. 8). Set the input selector to the same source if you wish to monitor

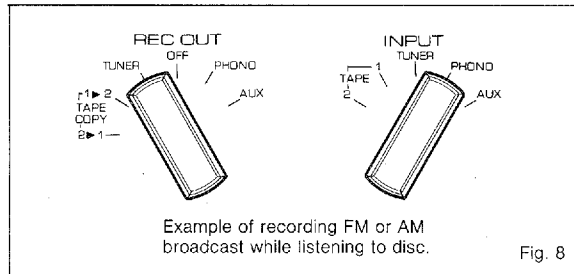

Example of recording FM or AM broadcast while listening to disc.

Fig. 8

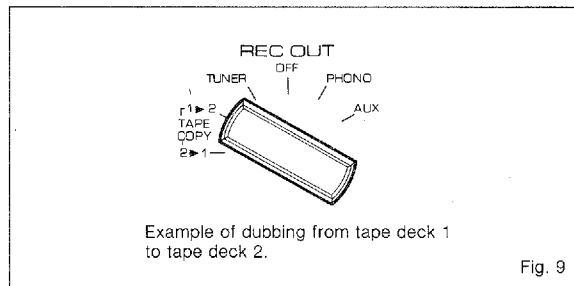

Example of dubbing from tape deck 1 to tape deck 2.

Fig. 9

R-700

the source as you record, or to any other source to listen to that source while recording. If your tape deck has three-head monitoring capability, you can monitor the signal just recorded on the tape by setting the Input Selector switch to Tape. Tapes may be dubbed from deck 1 to deck 2 by setting deck 1 to Play, deck 2 to Record, and the R-700's Rec Out switch to 1►2. Dubbing from deck 2 to deck 1 may be accomplished in a similar manner in the 2►1 position (See Fig. 9).

⑩ INPUT SELECTOR

Selects the program source to be listened to.

⑪ BALANCE CONTROL

This control lets you adjust the relative volume of the left and right speakers, enabling you to compensate for unbalance caused by the installation locations of the speakers and furniture arrangement.

⑫ LOUDNESS CONTROL

Compensates for our ears' reduced sensitivity to the extreme low and high frequencies at low volumes. Set it to the Flat position with the Volume control set to your loudest listening level. Rotate it to the left to reduce the volume while retaining the natural balance of the low and high frequencies.

⑬ MODE SWITCH

Allows switching between stereo and mono operation. Normally the switch should be set for stereo.

⑭ FM MUTING SWITCH

Turning this switch on (■) activates the muting circuit and silences the noise that would otherwise be heard between FM stations.

When the received station is very weak, it too will be silenced. Therefore, when you want to listen to a very weak station, the switch should be set to the Off/Mono position (■). The receiver automatically forces all stations to be received in mono in the Off/Mono position because the advantage in S/N ratio of mono over stereo allows quieter reception of weak stations.

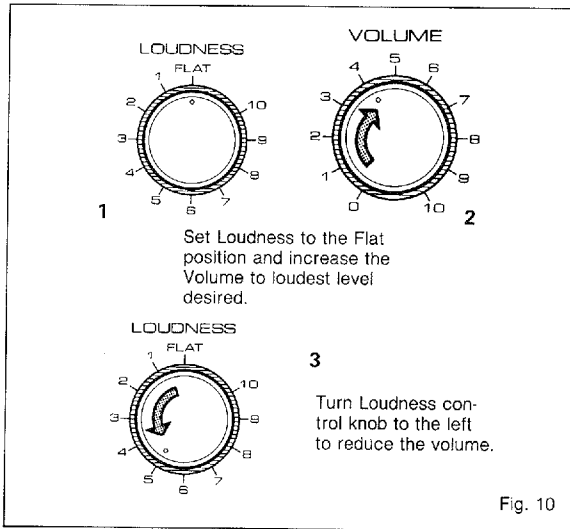

R-700 LISTENING TO A PROGRAM SOURCE

LISTENING TO FM BROADCASTS

1. Set the Input selector to Tuner.
2. Press the FM button.
3. Next, set the FM Muting switch to On (■) and the Mode switch to Stereo (■).
4. Press either the Up or the Down side of the Tuning button. The receiver will automatically scan the FM band in the selected direction. When a station is found, the scan will stop and the station will be locked in automatically. Use the Tuning button repeatedly to tune in your desired station.
5. When the station has been tuned in, the Station Lock light will come on, indicating that the station has been perfectly locked in. When the station is in stereo the FM Stereo indicator will light, while for mono stations the indicator will remain off.
 - * When listening to a weak, distant station or when there is interference from another station, setting the FM Muting switch to the Off/Mono (■) position will cause the station to be received in mono and considerably reduce noise.
6. Adjust the volume level and listen to the station.

LISTENING TO AM BROADCASTS

1. Set the Input selector to Tuner.
2. Press the AM button.
3. Press either the Up or the Down side of the Tuning button. The receiver will automatically scan the AM band in the selected direction. When a station is found, the scan will stop and the station will be locked in automatically. Use the Tuning button repeatedly to tune in your desired station.
4. When the station has been tuned in, the Station Lock light will come on, indicating that the station has been perfectly locked in.
 - * On rather weak AM stations the Station Lock indicator may remain off.
5. Adjust the volume level and listen to the station.

LISTENING TO RECORDS

1. Set the Input selector to Phono.
2. If your turntable is equipped with an MM cartridge it can be connected directly to the receiver, but if an MC cartridge is used an MC cartridge head amp or a step-up transformer will be necessary.
3. Place a record on the turntable and start it playing.
4. Adjust the volume level and listen to the record.
 - * When lowering the stylus to the record or raising the stylus from the record, turn the volume control all the way to "0".

RECORDING TAPES

1. Set the Rec Out selector to the source to be recorded.
2. Start the music from the selected source.
3. Set the recording level, etc. of the tape deck, and begin recording.
4. If your tape deck has three heads, setting the R-700's Input selector to the Tape 1 or Tape 2 position as appropriate will allow you to monitor the recorded material.
5. While recording the source selected with the Rec Out selector, any other source may be selected with the Input selector and listened to via the speakers.
 - * Adjusting the tone controls (Bass, Treble) or the volume control during recording has no effect on the material being recorded.
 - * The Tape Copy 1 ▶ 2 and the Tape Copy 2 ▶ 1 positions of the Rec Out selector are for tape dubbing. Please see Rec Out Selector (19) in the Front Panel section.

PLAYING BACK TAPES

1. Set the Input selector to Tape 1 or Tape 2 as appropriate.
2. Set the tape deck to Play.
3. Adjust the volume level and listen to the tape.

R-700 PRESET TUNING/ MEMORY BACK-UP POWER SUPPLY

PRESET TUNING

In addition to its auto-search tuning feature, the R-700 has a convenient programmable preset tuning system which allows you to tune in your favorite stations with the touch of a button.

To preset a station into the memory, first tune the station in. Check to see that the Station Lock indicator lights up. While pressing the Memory button, press one of the numbered preset tuning buttons. The tuner will then memorize the station's frequency. Any time the appropriate numbered button is pressed, the station will be automatically tuned in. After you have preset a station, it is a good idea to manually change to another frequency and then push the newly memorized station's button again to see that it is tuned in correctly. Up to 5 AM and 5 FM stations can be preset—a total of 10. In other words, each numbered button selects one of two stations—one FM and one AM—depending on which band has been selected.

To tune in a previously memorized station, first make sure that AM or FM has been selected as appropriate. Then press the numbered button corresponding to the desired station. The station will be automatically tuned in and its frequency will be displayed on the digital readout. The preset tuning button will light to indicate automatic station selection.

There may be cases where static electricity or electrical noise from fluorescent lamps or television sets prevents successful preset tuning. Set the tuner away from such sources of interference. When the button pressed has been preset to a very weak station or there is no broadcast station at the memorized frequency, the frequency may deviate slightly from the memorized frequency.

MEMORY BACK-UP POWER SUPPLY

In order to remember the frequencies of preset stations even when the unit is switched off, the R-700 continues to draw power even when switched off. In order to protect the memory contents in the event of a power failure a power storage unit is used. The receiver should be plugged in whenever possible to keep this memory back-up unit fully charged. If the receiver is normally turned on and off with a timer, charging will not occur, and the preset memory will be erased a short time after the unit is turned off. When the back-up power supply is fully charged the memory will be retained for about two days. It can be charged by plugging in the power cord to a wall outlet (the power switch does not need to be on).

R-700 SPECIFICATIONS

AUDIO SECTION

Minimum RMS Output Power per Channel	
8 ohms, 20 to 20,000 Hz,	
0.015% THD	50 W (17 dBW)
8 ohms, 1 kHz,	
0.01% THD	55 W (17.4 dBW)
Dynamic Headroom	
(8 ohms)	2.5 dB
Total Harmonic Distortion	
(20 to 20,000 Hz)	
Phono MM to Rec Out	
(3 V output)	0.005%
Aux/Tape to Sp Out	
(ohms, 1 W)	0.005%
Distortion Ratio	
Aux/Tape to Sp Out	
(8 ohms, 25 W)	0.01%
(8 ohms, 1 W)	0.015%
Power Bandwidth	
(8 ohms, 25 W,	
0.02% THD)	5 to 40,000 Hz
Damping Factor	
(8 ohms, 1 kHz)	Better than 40
Frequency Response	
(Aux/Tape to	
Sp Out, 8 ohms)	5 to 100,000 Hz
	-1 dB
RIAA Deviation	
Phono MM	±0.5 dB
Input Sensitivity/Impedance	
Phono MM	2.5 mV/47 k-ohms,
	220 pF
Aux/Tape	120 mV/47 k-ohms
Input Sensitivity (New IHF)	
Phono MM	0.35 mV
Aux/Tape	17 mV
Maximum Input Level (0.01% THD)	
Phono MM	
(20 to 20,000 Hz)	200 mV
Phono MM (1 kHz)	250 mV
Input Level/Impedance	
Rec Out	120 mV/470 ohms
Headphone Output	259 mW
	(0.015% THD)
Signal-to-Noise Ratio (IHF A Network)	
Phono MM (5 mV,	
Input Shorted)	85 dB
Aux/Tape	
(Input Shorted)	100 dB
Signal-to-Noise Ratio (New IHF)	
Phono MM	74 dB
Aux/Tape	85 dB
Residual Noise	
(IHF A Network)	115 µV
Channel Separation	
(1 kHz, vol -30 dB,	
5.1 k-ohms)	
Aux/Tape to	

Other Channel	-53 dB
Phono MM to	
Other Channel	-53 dB
Tone Control Characteristics	
Bass (boost/cut)	±10 dB at 50 Hz
Treble (boost/cut)	±10 dB at 20 kHz
Turnover Frequencies	
Bass	350 Hz
Treble	3.5 kHz
Filter Characteristics	
Low (Subsonic,	
EQ Built-In)	10 Hz, -12 dB/oct
High	8 kHz, -6 dB/oct
Continuous Loudness Control	
(Level-Related Equalization)	
Max. Attenuation	-20 dB at 1 kHz
Rec. Output Level/Impedance (Fixed)	
FM (100% mod.	
1 kHz)	500 mV/4.7 k-ohms
AM (30% mod.	
1 kHz)	150 mV/4.7 k-ohms

FM SECTION

Tuning Range	
	87.6 to 108 MHz
50 dB Quieting Sensitivity	
Mono (DX)	3.2 µV (15.3 dBf)
Stereo	
(DX, Auto Blend)	25 µV (33.3 dBf)
Usable Sensitivity	
IHF Mono (1 kHz 100% mod.)	
(300 ohms)	2.5 µV (13.2 dBf)
(75 ohms)	1.25 µV (13.2 dBf)
Image Response Ratio	
(98 MHz)	62 dB
IF Response Ratio	
(98 MHz)	100 dB
Spurious Response Ratio	
(98 MHz)	100 dB
AM Suppression Ratio	
(IHF)	65 dB
Capture Ratio (IHF)	
(IHF)	Local 1.5 dB
	DX 2.2 dB
Alternate Channel Selectivity	
(IHF)	Local 30 dB,
	DX 82 dB,
Selectivity	
(Two Signals)	DX 68 dB
Signal-to-Noise Ratio	
Mono	84 dB
Stereo	80 dB
Distortion	
Mono 100 Hz	Local 0.06%
	DX 0.1%
1 kHz	Local 0.06%,
	DX 0.3%
6 kHz	Local 0.08%,
	DX 0.7%
Stereo 100 Hz	Local 0.07%,
	DX 0.1%

1 kHz	Local 0.07%,
	DX 0.5%
6 kHz	Local 0.09%,
	DX 0.8%
Intermodulation Distortion (IHF)	
Mono	Local 0.07%,
	DX 0.5%
Stereo	Local 0.08%,
	DX 1.0%
Stereo Separation (Local)	
50 Hz	44 dB
1 kHz	50 dB
10 kHz	45 dB
Frequency Response	
50 Hz to 10 kHz	±0.3 dB
30 Hz to 15 kHz	±0.5 dB
Subcarrier Product	
Ratio	50 dB
Muting Threshold	
(DX)	5 µV (19.2 dBf)
Auto-DX Threshold	30 µV (34.8 dBf)

AM SECTION

Tuning Range	
	525 to 1,605 kHz
Usable Sensitivity	
(Loop Antenna)	200 µV
Selectivity	
	30 dB
Signal-to-Noise	
Ratio	50 dB
Image Response	
Ratio	40 dB
Spurious Response	
Ratio	50 dB
Distortion (1 kHz)	0.3%

GENERAL

Semiconductors	
	42 Transistors,
	20 ICs,
	3 FETs, 31 Diodes,
	14 LEDs
Power Supply	
U.S. and Canada	120 V, 60 Hz
General	110—120 V/
	220—240 V,
	50/60 Hz
Northern Europe	220 V, 50 Hz
Britain and	
Australia	240 V, 50 Hz
Power Consumption	
U.S. and Canada	200 W
Northern Europe	320 W
Britain and	
Australia	320 W
General	120 W
Dimensions	
(W x H x D)	480 x 122 x 337 mm
	(18-7/8" x 4-3/4" x
	13-1/4")
Weight	
	9.0 kg
	(19 lbs. 13 oz.)

Specifications subject to change without notice.

R-700 TROUBLESHOOTING

Before assuming that your receiver is faulty, check the following troubleshooting list which details the corrective action you can take yourself without having to call a service engineer. If you have any doubts or questions, get in touch with your nearest Yamaha dealer.

	FAULT	CAUSE	CURE
AUDIO	Power is not applied even though the Power switch is turned on.	The power cord is not plugged in.	Plug in the power cord.
	There is no sound with any position of the Input selector.	The Speakers switches are not set correctly	Set them correctly.
		The input cords are not connected securely.	Plug them in securely.
	There is no sound from one speaker.	The speaker connections are not secure.	Secure the connections.
		The Balance control is set all the way to the left or right.	Adjust the Balance control correctly.
	There is a lack of bass and no ambience.	The + and - cords have been reversed at the amp or the speakers.	Connect the speaker wires in the correct phase (+ and -).
	There is a humming sound when playing records.	The input cords are not connected securely.	Plug the input cords in securely.
The turntable's ground wire is not connected.		Connect the ground wire.	
There is a howling sound when playing records at high volume.	The turntable and the speakers are too close together or the turntable is not mounted on a firm surface.	Change the location of the turntable or the speakers.	
Unable to record.	The Rec Out selector is set to Off.	Set the Rec Out selector to the source to be recorded.	
Crackling sounds from time to time (especially in weak signal areas).	Ignition noise from vehicles.	The FM antenna should be put up as high as possible, away from the road, and a coaxial cable used.	
	Noise from thermostats and other electrical equipment.	Attach a noise suppressor to the equipment causing the noise.	
The FM stereo reception is noisy.	Because of the characteristics of FM stereo broadcasts, this is limited to cases where the transmitter is far away or the antenna input is poor.	Check the antenna connections.	
		Try using a multiple element FM antenna.	
		Set the FM Muting switch to the Off/Mono position.	
The FM Stereo indicator flickers on and off and reception is noisy.	Insufficient antenna input.	Use an antenna appropriate for the reception conditions in your area.	
	Not tuned correctly.	Tune again.	
There is distortion and clear reception cannot be obtained even with a good FM antenna.	There is multipath interference.	Adjust antenna placement to eliminate multipath interference.	
The Signal Quality Indicator lights up but there is no sound.	The muting circuit has turned off the sound because the received station is very weak.	Set the FM Muting switch to the Off/Mono position to disable muting.	
No stereo effect even with a stereo broadcast.	The Mode switch is set to Mono or the FM Muting switch is set to Off/Mono.	Set these switches properly.	
A desired station can not be tuned in with Auto Tuning.	The station is too weak.	Use a high-quality directional FM antenna.	
Previously preset stations can no longer be tuned in.	The tuner was unplugged for more than two days.	Repeat the preset procedure.	
Insufficient sensitivity.	Weak signal or loose antenna connections.	Tighten the AM loop antenna connections and rotate it for best reception.	
		Use an outdoor antenna.	
There are continuous crackling and hissing noises.	These noises result from lightning, fluorescent lamps, motors, thermostats and other electrical equipment.	Use an outdoor antenna and a ground wire. This will help somewhat but it is difficult to eliminate all noise.	
		Another station is interfering with the received station.	
There are buzzing and whining noises.	A television set is being used nearby.	This is impossible to remedy.	
		Move the television a distance away.	

R-700 BLOCK DIAGRAM

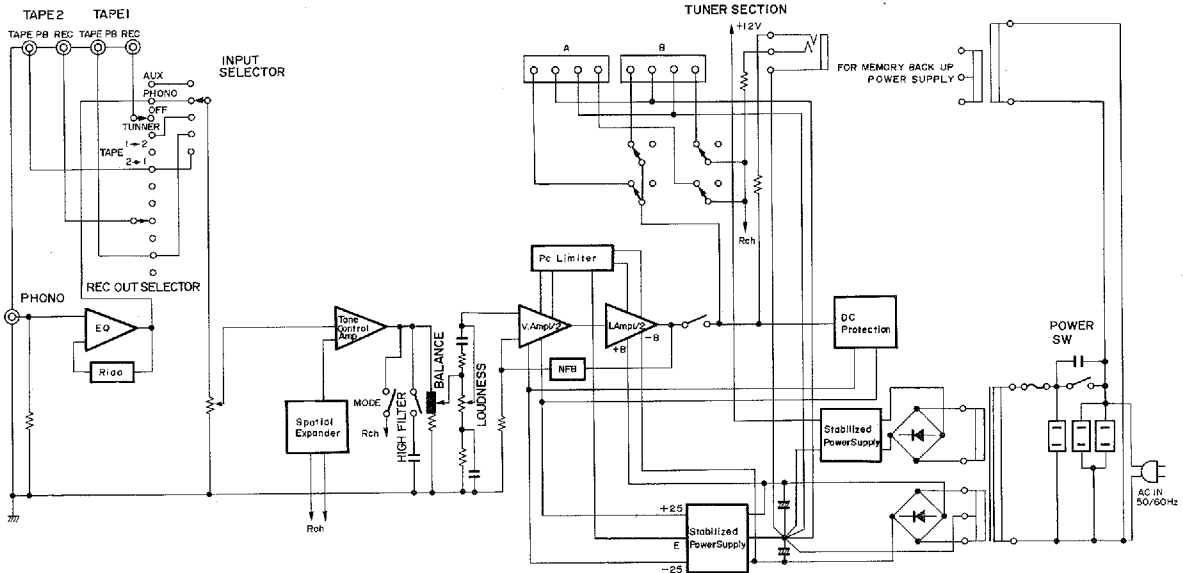
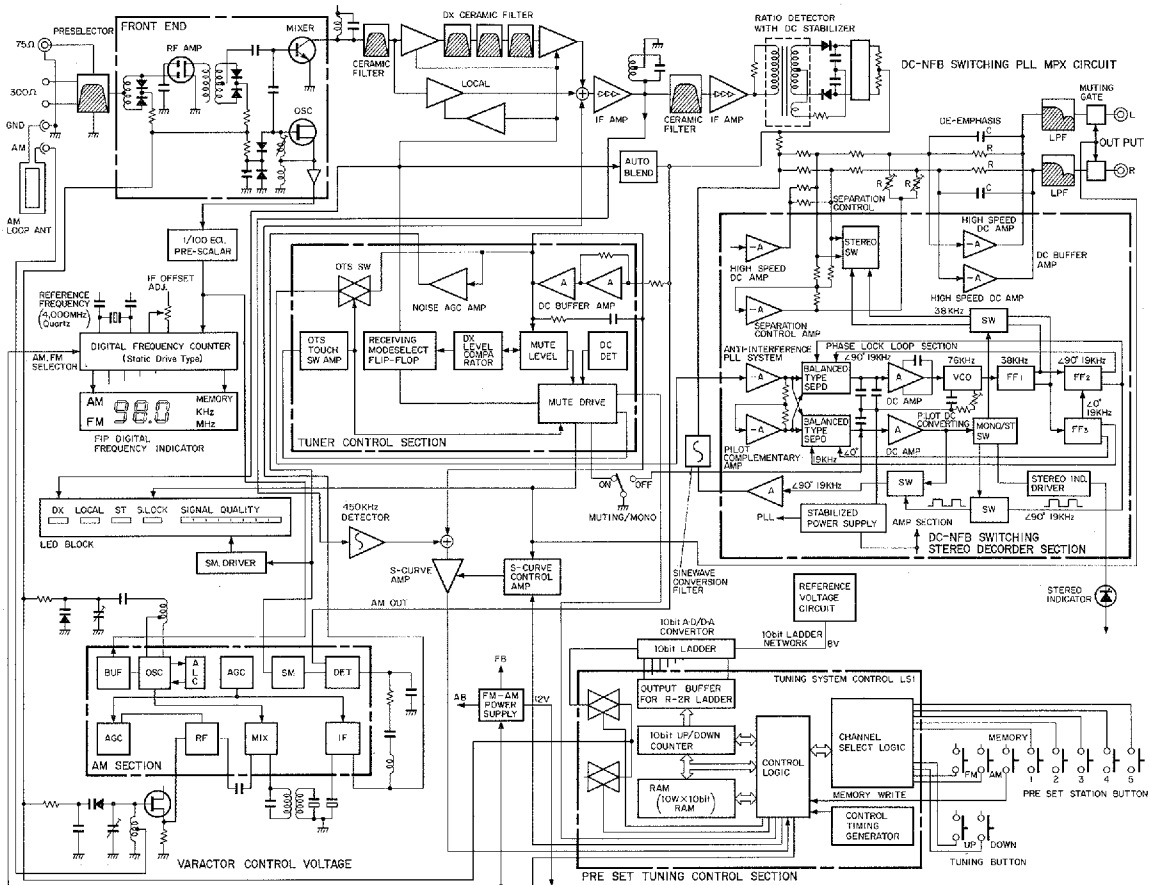

SINCE 1887  **YAMAHA**
NIPPON GAKKI CO., LTD. HAMAMATSU, JAPAN